

SHOWCASE LINEAR RGBW

Exterior LED liner

SHOWCASE
SERIES

Features

- Slim size – easy fit in different architectural structures
- Dedicated optic design – even washing effect, optimized color mixing
- DMX Control – dynamic lighting control
- Easy installation and maintenance – auto-addressing and reliable connection by self-locking water-proof connectors



Optical Specifications

Luminous flux	Short.....	383 lm
RGBW (W: 4000 K)	Long.....	1533 lm
Efficacy	White	80 lm/W (4000 K)
	RGBW	35 - 45 lm/W (W: 4000 K)
CCT	RGBW	
CRI	80 (White LED)	
Beam angle	RGBW.....	20° x 30°

Electrical/Mechanical Specifications

Input voltage	24 VDC
Power consumption	Short.....12 W
	Long.....36 W
Dimensions L x W x H	Short.....11.81" x 1.61" x 1.14"
(Excluding mounting bracket)	Long.....39.37" x 1.61" x 1.14"
Weight	Short.....1.76 lbs.
	Long.....4.41 lbs.
Cover lenses	Semi-tempered glass cover
Housing	Aluminum

System Specifications

Control	DMX
Max. interconnection	Short.....8 units
	Long.....2 units
Adjustment options	±90° tilt
Operating temperature	-4° F - 122° F
Storage temperature	-40° F - 176° F
Environment	Outdoor (IP66)
Lumen maintenance	L ₇₀ @ 25° C - 50,000 hours
Safety approval	Electrical Protection Class III, CE, CB, UL
Warranty	3-year parts only

Dimensions

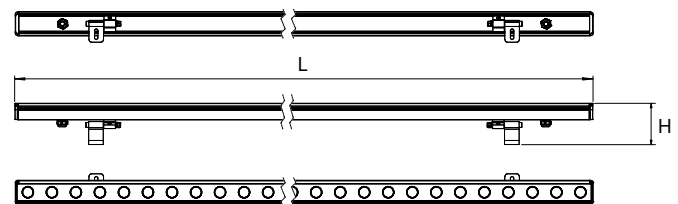

	Linear Short	Linear Long
L	11.81"	39.37"
W	1.61"	1.61"
H	2.83"	2.83"
H1	1.10"	1.10"
H2	1.69"	1.69"

Product Options

Showcase Linear RGBW Fixtures	Part number
Showcase Linear RGBW 12 W 12 x 50 Short	P-LM2550-12W-3C
Showcase Linear RGBW 36 W 25 x 50 Long	P-LN2550-36W-3C

Showcase Linear RGBW Cables	Part number
Showcase Linear 5-pin Starter Cable 6-ft	P-LN-5PS-2M
Showcase Linear 5-pin Interconnection Cable 3-ft	P-LN-5IC-1M
Showcase Linear 5-pin Interconnect Cable 6"	P-LN-5PC-4DC
Showcase Linear 5-pin Interconnection Power Injection Cable	P-LN-5IT-CAB
Showcase Linear 5-pin Connector Socket End Cap	P-LN-5PC-EC



Specifications subject to change without notice.



SHOWCASE LINEAR RGBW

Exterior LED liner

SHOWCASE SERIES

Showcase Linear System Diagram

DC DMX version – Accessories

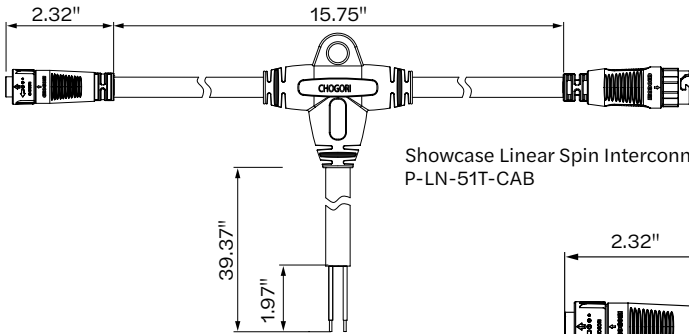

Showcase Linear Spin Interconnection Power Injector
P-LN-51T-CAB

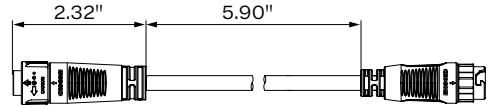

Showcase Linear Spin Cable 6"
P-LN-5PC-70C

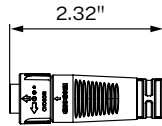

Showcase Linear 5-pin End Cap
P-LN-5PC-EC

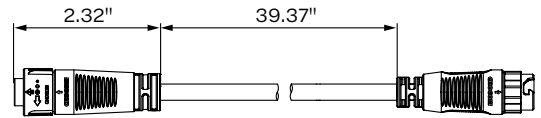

Showcase Linear 5-pin Cable 39"
P-LN-51C-IM

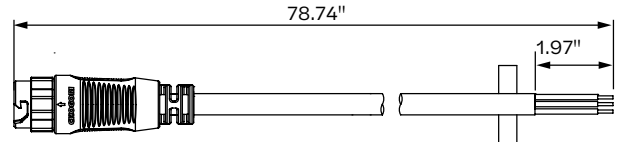

Showcase Linear 5-pin Starter Cable
P-LN-5PS-2M

DC DMX Version System Diagram

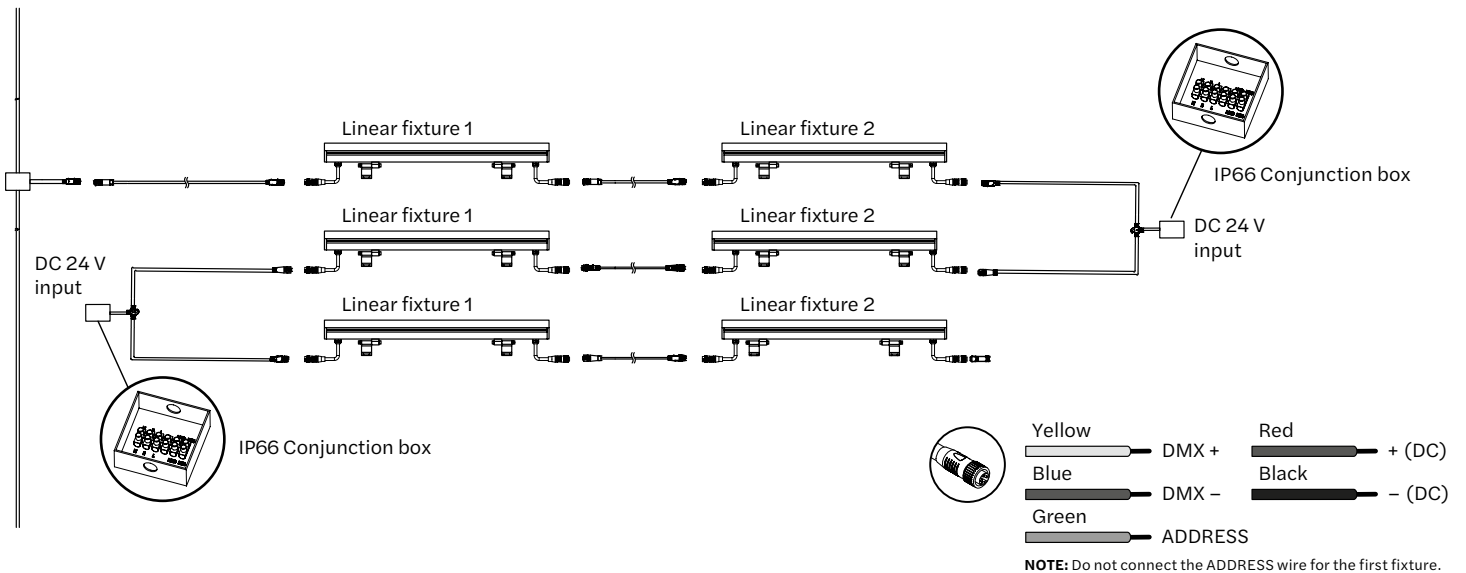

pindustries.com
 325.227.4577
 3490 Venture Dr., San Angelo, TX 76905

© 2023 Principal Industries Rev A 2023-06-07

