

SignBOX II

Installation Guide for 701946-(X)WD201, 701946-(X)WS201

WARNING: Risk of electrical shock. New installation and LED Retrofit Kit installation requires knowledge of sign electrical systems. If not qualified, do not attempt installation. Contact a qualified electrician. Follow all NEC and local codes. SignBOX II is not suitable for submersion or direct exposure to water for extended periods of time.

AVERTISSEMENT: Risque de choc électrique. La nouvelle installation et l'installation du kit de modification à LED nécessitent la connaissance des systèmes électriques de signalisation. Si non qualifié, ne tentez pas l'installation. Contactez un électricien qualifié. Suivez tous les codes NEC et locaux. SignBOX II ne convient pas à la submersion ni à l'exposition directe à l'eau pendant de longues périodes.

For New Installation, proceed with Step 1 below. For Retrofit Installations, begin with Retrofit Instructions on page 3.

New Installation

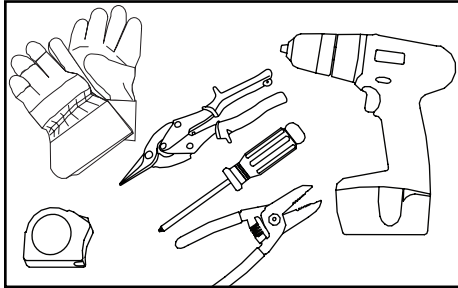

- 1. Tools required:** Measuring tape, wire strippers, gloves, cutting tool (sheet metal shears/snips, scissors, utility knife), drill, and screwdriver.

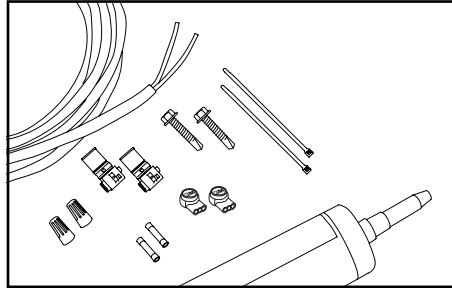

ATTENTION: Only install SignBOX II when ambient temperature is above 5° C (41° F).

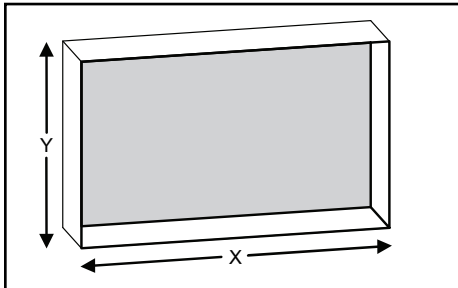

- 3. Measure sign cabinet to determine quantities of SignBOX II.**

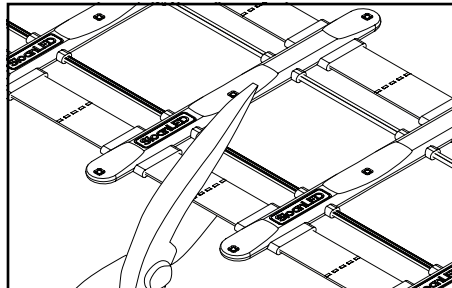

- 4. Cutting product:** Cut straps (along dashed lines) and wires between modules to obtain required length. **Tip:** Before cutting wires, refer to Joining Product section.

2. Components list:

- SignBOX II assemblies
 - Double-sided assemblies:** model numbers 701946-(X)WD201
 - Single-sided assemblies:** model numbers 701946-(X)WS201
- SloanLED 12 V Class 2 output power supply (refer to "SloanLED Power Supply Guide for Sign Products" for appropriate model numbers)
- UL approved 18 AWG (1 mm²) or larger diameter supply wire
- UL approved wire connectors appropriate for wire gauge used
- SignBOX II mounting hardware (as needed): Clamps (P/N 410155), Couplers (P/N 401330), and Brackets (P/N 401309)
- #8 (M4) self-drilling/self-tapping tek screws (required to pierce through strap), minimum length 5/8" (16 mm)
- Optional: Electrical grade silicone, nylon zip ties, double-stick mounting tape

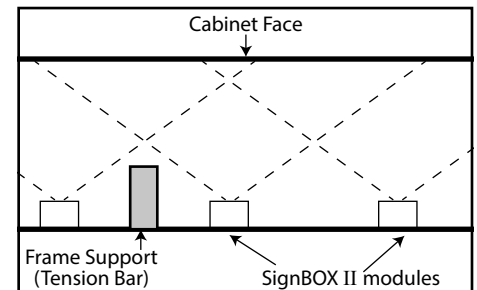

NOTE: To minimize the potential for shadows in applications when using frame support tubes, mount modules or frame support tubes such that the tubes are centered in between modules and at a depth that will not directly interfere with the beam angle of the LEDs.

Use SignComp Adjustable Frame Brace (P/N 5357) or equivalent.

SignBOX II

Installation Guide for 701946-(X)WD201, 701946-(X)WS201

Joining Product

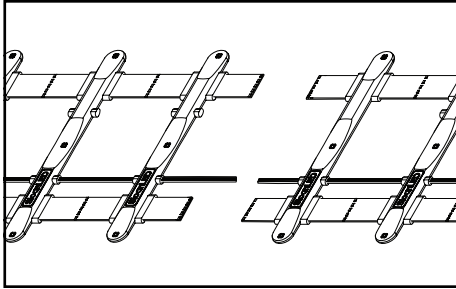

5. When cutting wires between modules, leaving one side longer will aid in joining product where needed. If, however, wires are not long enough for connections, use either jumper wires or remove a module to maximize wire length.

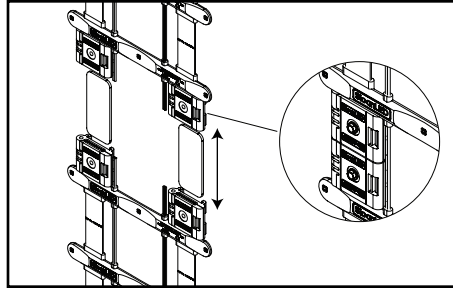

6. Use SignBOX II Clamps (P/N 410155) and SignBOX II Couplers (P/N 401330) to join shorter pieces of product to required length. Insert straps from both sides of modules into clamps (track features facing same direction) making sure clamps are flush against modules, snap closed (avoid pinching wires), slide onto couplers, and secure to them with #8 (M4) tek screws. Connect wires.

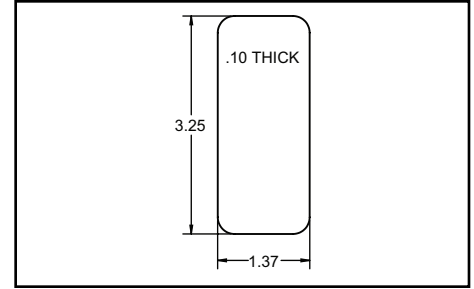

SignBOX II Coupler dimensions: 3.25" x 1.37" x .10" (82.5 mm x 34.8 mm x 2.5 mm)

Structural Support Guidelines for SignBOX II

Vertical mounting: space supports at even intervals, but no further apart than 8 ft (2.4 m).

Horizontal mounting: space supports at even intervals, but no further apart than 4 ft (1.2 m).

Mounting Product

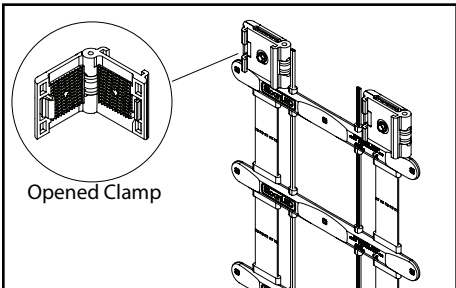

4a. **Mounting modules with SignBOX II Clamps (P/N 410155) directly to cabinet:** Insert straps from both sides of module into clamps (track features facing away from mounting surface) making sure clamps are flush against module, snap closed (avoid pinching wires), and secure to cabinet structure using #8 (M4) tek screws*. Repeat on opposite end making sure product is taut.

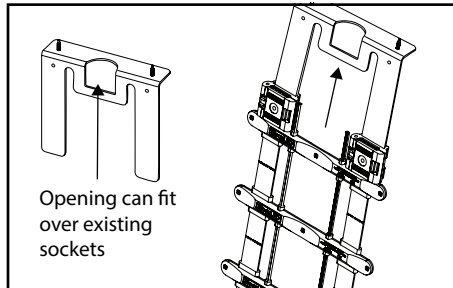

4b. **Mounting modules with SignBOX II Clamps (P/N 410155) using SignBOX II Brackets (P/N 401309):** Install brackets 12" (305 mm) center-to-center along returns of cabinet*. Insert straps from both sides of module into clamps (track features facing same direction) making sure clamps are flush against module, snap closed (avoid pinching wires), slide onto bracket, and secure to it with #8 (M4) tek screws. Repeat on opposite end making sure product is taut.

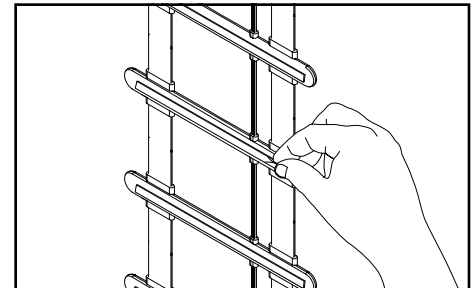

4c. **Optional mounting in single-sided cabinet with double stick tape:** Using non-oil based cleaner, clean all mounting surfaces of sign and bottom of modules for proper tape adhesion. With double stick tape on bottom of modules, mount to back of cabinet. Make sure product is taut. (Double stick tape is not included.)

* Refer to Density Guidelines to determine SignBOX II product and installation method.

SignBOX II

Installation Guide for 701946-(X)WD201, 701946-(X)WS201

Connecting Product to Power Supply

Single-sided option

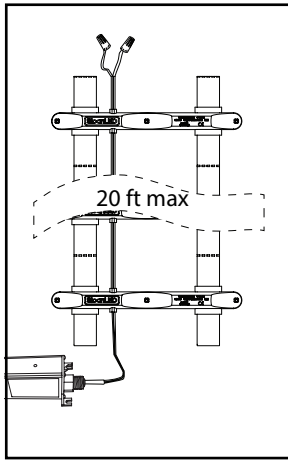

Double-sided options

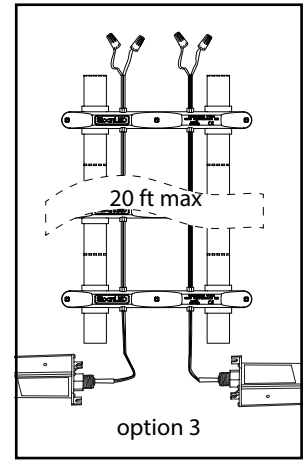
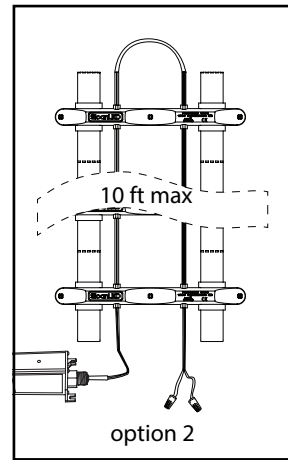
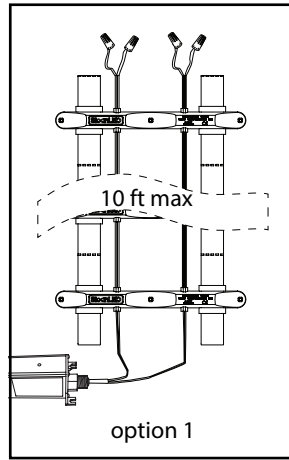

5. Using electrical connectors with appropriate safety agency markings, daisy chain product as required and connect to power supply as shown above. **CAUTION! Have a licensed electrician connect primary. ATTENTION! Demandez à un électricien agréé de connecter le primaire.** Modules may be connected in series or parallel. End wires of SignBOX II should be capped and not tied back to power supply.

WARNING check polarity: All connections must be RED-TO-RED (+) and BLACK-TO-BLACK (-). Reverse polarity connections may damage the LEDs and will void product warranty. **AVERTISSEMENT vérifier la polarité:** toutes les connexions doivent être ROUGE-ROUGE (+) et NOIR-NOIR (-). Des connexions inversées peuvent endommager les DEL et annuler la garantie du produit.

Retrofit Instructions for Existing Signs



GENERAL PURPOSE
RETROFIT SIGN CONVERSION.

FOR USE ONLY IN ACCORDANCE
WITH KIT INSTRUCTIONS.

KIT IS COMPLETE ONLY WHEN ALL PARTS
REQUIRED BY THE INSTRUCTIONS ARE PRESENT.

WARNING: Risk of fire or electric shock. Install this kit only in host signs that have been identified in the installation instructions, and where the input rating of the retrofit kit does not exceed the input rating of the sign. Installation of this LED retrofit kit may involve drilling or punching of holes into the structure of the sign. Check for enclosed wiring and components to avoid damage to wiring and electrical parts. **AVERTISSEMENT:** Risque d'incendie ou de choc électrique. Installez ce kit uniquement sur les panneaux hôtes identifiés dans les instructions d'installation et dans lesquels les caractéristiques nominales d'entrée du kit de modification ne dépassent pas celles du panneau. L'installation de ce kit d'amélioration des LED peut impliquer de percer ou de percer des trous dans la structure de l'enseigne. Vérifiez le câblage et les composants inclus pour éviter d'endommager le câblage et les pièces électriques.

1. Identify sign to be retrofit and ensure branch circuit supplying existing sign are within voltage range for LED power supply. Refer to components list (page 1) and "12 VDC Power Supply Capacity Chart" (page 4).
2. Remove existing lighting equipment intended to be replaced, such as neon or fluorescent, and all power supplies, transformers, or ballasts. If previous sign is neon, remove existing neon and all standoffs to leave an empty sign cabinet. NOTE: All materials removed must be disposed of in accordance with applicable local, state, and federal laws.
3. If required by local, state, or national electrical code, install a new disconnect switch.
4. Determine suitability and structural integrity of existing sign after removal of existing lighting equipment. If retrofit does not require the making of any new holes, do not make or alter any open holes in an enclosure of wiring or electrical components during kit installation. If existing holes are present in a wet or outdoor location sign, repair and seal any unused openings in the electrical enclosure. Openings greater than 0.5" (12.7 mm) diameter require a metal patch secured by screws or rivets and caulked with non-hardening caulk. Smaller openings may be sealed with non-hardening caulk.
5. Clean inside of sign using non-oil based cleaner. Follow all manufacturer's instructions and ensure inside of sign is dry before proceeding with installation. This is an important step for good adhesion of SignBOX II module mounting tape.
6. To populate sign, refer to SignBOX II density guidelines as well as power supply capacity chart (page 4) to determine appropriate number of modules and power supplies. A list of acceptable power supply models is shown in the supplemental "SloanLED Power Supply Guide for Sign Products".
7. Follow all instructions on pages 1 and 2 under "New Installation" to properly install LED modules.
8. Connect modules to power supply output as shown on page 3 under "New Installation".
9. Connect power supply input as outlined in power supply installation guide in accordance with local, state and national electrical codes by qualified personnel. Refer to power supply install guide included with power supply for details.
10. If required, install disconnect switch in accordance with local, state and national electrical codes by qualified personnel.

SignBOX II

Installation Guide for 701946-(X)WD201, 701946-(X)WS201

12 VDC Power Supply Capacity Chart

Power output	Maximum modules single-sided or one leg of double-sided	Maximum modules double-sided, both legs
20 W	20	10
25 W (EU/ROW ONLY)	25	12
30 W (EU/ROW ONLY)	30	15
60 W	60	30
2 × 60 W	60 × 2	30 × 2
2 × 75 W* (EU/ROW ONLY)	75 × 2	37 × 2
100 W* (EU/ROW ONLY)	100	50
Power used per ft (m) in watts	2.7 W (8.9)	5.4 W (17.7)

* Must split load at power supply output to prevent exceeding maximum wire/module ampacity of 5A per single leg.

Capacities based on 90% of power supply output.

NOTE: Refer to "*SloanLED Power Supply Guide for Sign Products*" for appropriate 12 V power supply models.

Scan QR code to download SloanLED Power Supply Guide for Sign Products



<https://sloanled.com/downloads/SloanLEDPowerSupplyGuideForSignProducts.pdf>

Extension of Power Supply Leads

If longer lead wire from power supply to LED modules is needed, an extension can be used. Extension should be kept as short as possible, i.e., under 15 ft for 18 AWG UL Listed PLTC (4.6 m for 1 mm² PLTC) or under 50 ft for 14 AWG UL Listed PLTC (15.2 m for 2.5 mm² PLTC).

Troubleshooting:

Entire box/cabinet or product does not light after complete installation.	Check connection from power supply lead to first module. Make sure polarity of connections made at power supply lead and any jumper wire is correct. Power supply outputs should be connected RED-TO-RED and BLACK-TO-BLACK.
Still does not light.	Check output voltage of power supply using a voltmeter. The output voltage should be DC 12.0 V ± 0.5 V. If there is no output voltage, have a licensed electrician check input voltage. Make sure power supply is connected correctly and getting primary power. If power supply is connected properly and getting primary power and there is still no output voltage, try a different power supply.
Still does not light.	If power supply is getting primary power and modules don't light, there may be a short in the secondary wiring. Check all connections and cap all loose wires.
The beginning of a strip lights, but entire strip does not light or lights intermittently.	The primary cause of a portion of a strip is not lighting or lighting intermittently is a bad connection or reverse polarity connection between modules that light and modules that don't light. Check this connection.
One module does not light, but all others in the product light.	SignBOX II is designed so if one module fails, it will not cause the entire box/cabinet or strip to go out. If one module does not light, but all others in the product do, replace this module with a new one.



US patents and foreign patents pending

Customer service and technical support

SloanLED Headquarters

5725 Olivas Park Drive, Ventura, CA, USA
888.747.4LED (888.747.4533) • info@SloanLED.com

SloanLED.com

SloanLED Europe b.v.

Argonstraat 110, 2718 SN Zoetermeer, NL
+31 88 12 44 900 • Europe@SloanLED.com

