

STREET WRAP™ FLEX SIDE-BEND

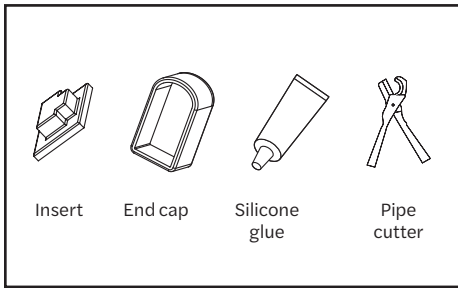

Cutting and Sealing



Installation tools & components

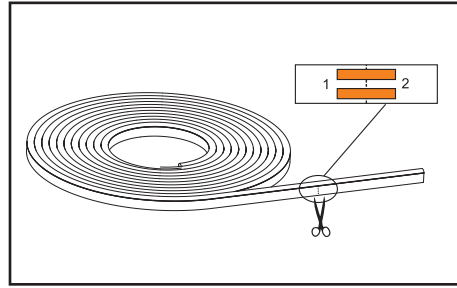

1. Cut on designated cut mark.

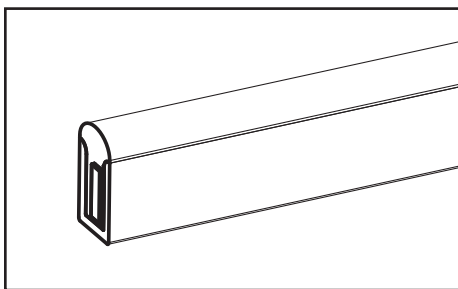

2. Clean cut end before next steps.

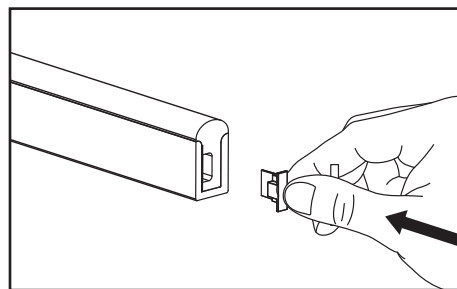

3. Install silicone insert after cut.

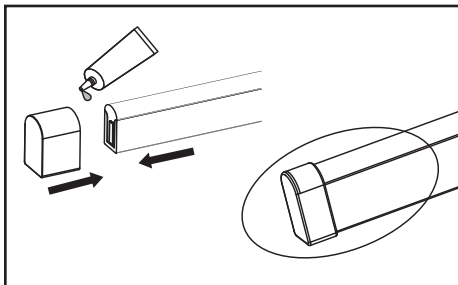

4. Coat end cap with silicone glue and install.

CAUTION

Do **NOT** twist and bend this product abruptly or severely.



This action may cause copper trace or solder connections to crack, resulting in section outages along the strand.

TAKE EXTREME CAUTION WHEN UNBOXING AND INSTALLING.

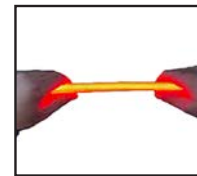

Normal flex



Unnatural bend



Section outage



Result of twist & bend

Outages caused by these actions may void your warranty.

Unwind Flex strip from coil or reel carefully and without twisting.

STREET WRAP™ FLEX SIDE-BEND



Installation NOTE: There are no pre-drilled holes in the aluminum extrusion, please drill holes accordingly to meet field requirements, using the appropriate screw.

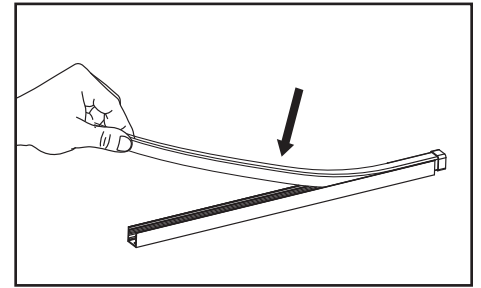
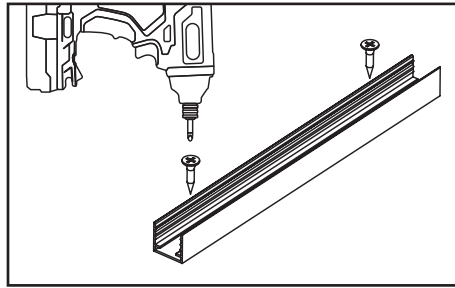
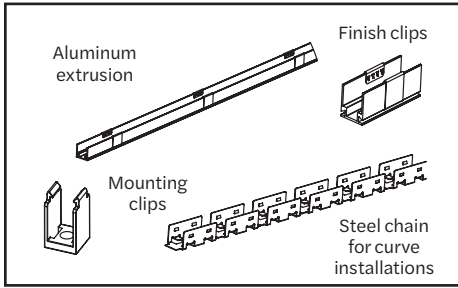

Mounting Accessories

1. Drill screw hole and install mounting accessories with screws provided.

2. Gently press product into mounting accessories.

Warnings

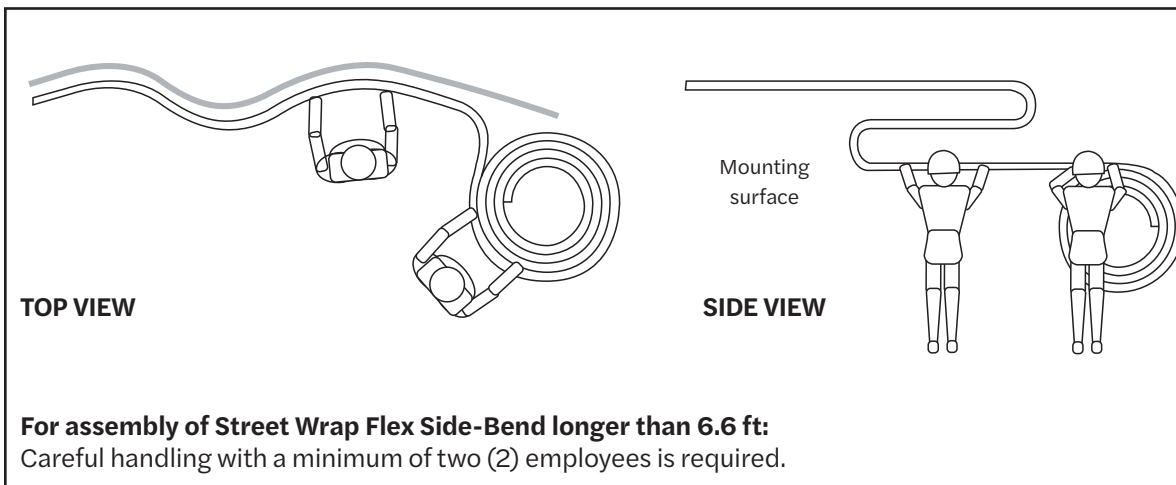
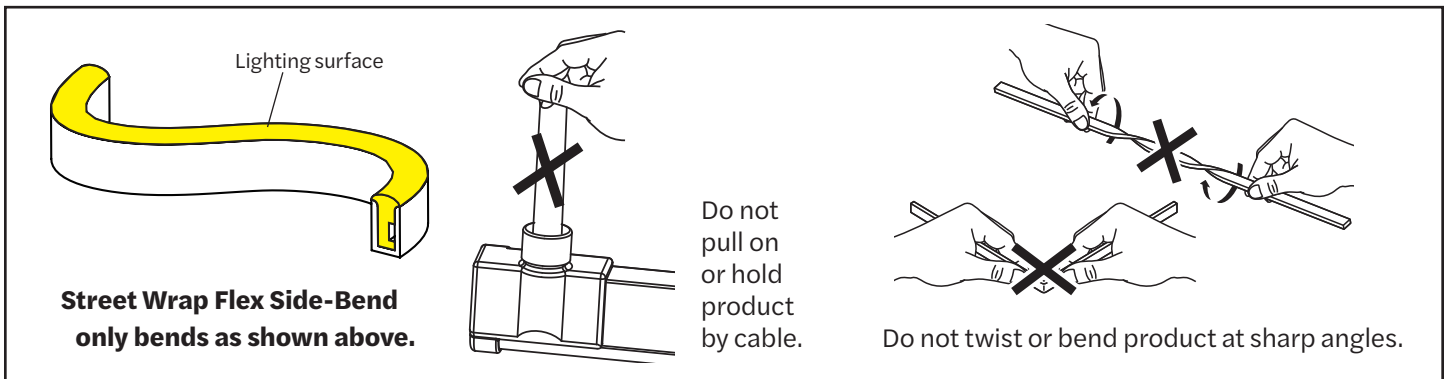

Customer service and technical support

- principalsloan.com
- 325.227.4577
- 3490 Venture Dr., San Angelo, TX 76905

