

T3M RGB CONTROLLER



T3M 2.4G LED RGB Controller



T3M is the 2.4GHZ RF wireless synchronization/zone RGB controller which adopts LTECH multiple globalinitiate technology. The control system consists of two parts, the RF remote control and receiver, realize the signal synchronization on multiple receivers, zone controlled arbitrarily (no more than 10 zones) within effective distance, a very good solution for the LED project needs sync control wirelessly. User-friendly touch full-color wheel for color selection, unique LED state light for sync change indicated, user can simply know the LED working state from distance by checking the remote control. Can RF remote the functions of switch, pause, changing modes, changing speed and the brightness and so on. Satisfied with your requirement of sync control multiple zones, group control or control separately, which t is easy to use.

1. Technical Specs:

T3M Remote Control (P-C15-WR)

- Input Voltage: DC5V Built-in Lithium Battery
- Working Current: <30mA
- Working Frequency: 2.4GHZ
- RF Remote Distance: 30m
- Remote Option: Sync or Zone Control
- Change mode: 18 Fantastic modes
- Battery Capacity: 1000mAh
- Standby Time: 6 months
- Normal Using Time: 30 days
- Dimension: L145×W55×H22(mm)
- Package Size: L168×W102×H28(mm)
- Weight (G.W.): 200g

T3-5A CV Receiving controller (P-C315)

- Input voltage: DC12V-DC24V
- Max current load: 5A×3CH Max 15A
- Max output power: 180W/360W(12V/24V)
- Control button: 8 touch button
- Compatible remote control: workable with T3, T3M, T3X
- Working temperature: -30℃~55℃
- Dimension: L211×W40×H30mm
- Package size: L215×W42×H32mm
- Weight (G.W.): 180g

2. Product Size:

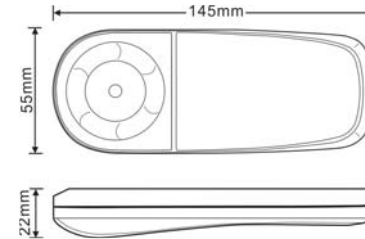

T3M RF remote control

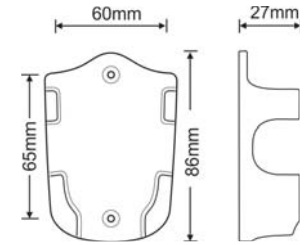

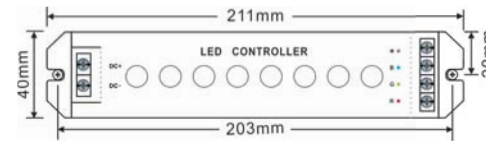

Remote holder





T3-5A

3. The learning ID method of remote control:

T3-5A learning ID:

1. Turn on the receiver and remote control.
2. Press "on/off button"  on the T3-5A for 2 seconds, there is a buzzer sound, and do not release your hand on the button , at the same time press any keys of 1-10 zone on the remote control, until the green indicator light  of remote control flashes 3 times(a voice prompt at the same time), release all the keys.

T3-5A cancelling ID:

1. Turn on the receiver and remote control.
2. Press "on/off button"  on the T3-5A for 2 seconds, there is a buzzer sound, and do not release your hand on the button , after 5 seconds press any keys of 1-10 zone on the remote control, until the red indicator light  of remote control flashes 3 times(a voice prompt at the same time), release all the keys.

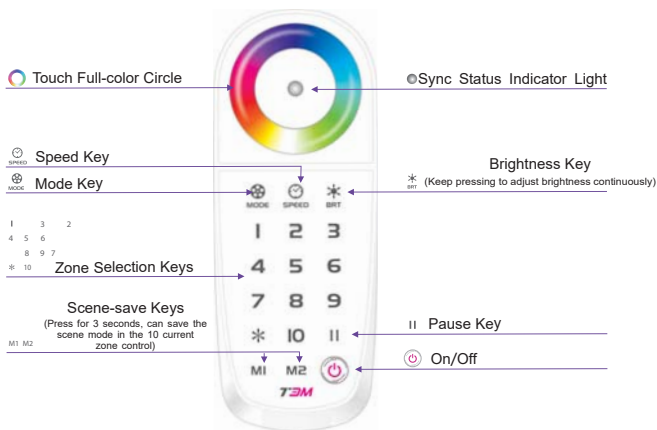
4. Operation Panel and Component Instruction:

Zoning Instructions:

Select one of the zone: Press keys 1-10 on the remote control.

Select zone control arbitrarily :Press"*+any number+*", eg: take 456 as a zone, should press"*456*"

All choose(10 zones): Press"*" twice.

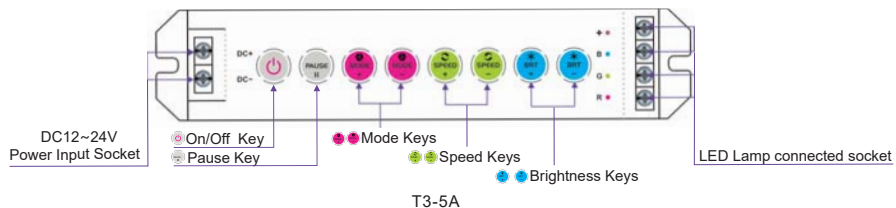
Press "Pause" button in 3 seconds, the buzzer can be on or off.

5. Other Special Functions:
A. Reset Function:

Feature: Reset function is available when remote operates abnormally.

Operation: Long press  simultaneously, release the 2 keys after 3 seconds, the remote will auto off, means reset completed. and then could restart the remote.



B. Check and Edit the Frequency Point on the Remote:

Feature:

- Revising the frequency point to eliminate the external disturbance. 12 revisable frequency points for user.
- Multiple remotes sync-control becomes available when they use the same frequency point.



Attn: After reset or revised the frequency points in the remote, receivers only can be used after relearn the ID.

Check the Frequency Point on the Remote:

Turn on the remote, long press the on/off key  for 5 seconds until the red light  flashes 3 times, and then the green light  flashes, the numbers of the green flash will be the frequency point of the remote. you can only edit the frequency point after 3 seconds.

Edit the Frequency Point on the Remote: In frequency changing state

Method 1: short press any key from 1-9, the frequency point will be 1-9 correspondingly, the green light will flash in the same numbers. Press again any key or touch the color circle to exit the frequency edit state.

Method 2: long press "on/off" key  over 5 seconds, the green light  flashes, the flash times plus 1 means the frequency point accumulate 1. In short, long press the "on/off" key  5 seconds each time, the frequency point will accumulate 1, which will again become value 1 when added to 12, and that cycle repeats.

6. Tables of Changing Mode:

No.	Mode	Description	No.	Mode	Description
1	3 Colors Skipping	Speed/Brightness Adjustable	10	Green Cyan Color Smooth	Speed/Brightness Adjustable
2	7 Colors Skipping	Speed/Brightness Adjustable	11	Blue Purple Color Smooth	Speed/Brightness Adjustable
3	White Strobe	Speed/Brightness Adjustable	12	Green Yellow Color Smooth	Speed/Brightness Adjustable
4	7 Colors Strobe	Speed/Brightness Adjustable	13	Blue Cyan Color Smooth	Speed/Brightness Adjustable
5	Rgb Fade out and Fade in	Speed/Brightness Adjustable	14	Red Purple Color Smooth	Speed/Brightness Adjustable
6	Red Green Color Smooth	Speed/Brightness Adjustable	15	Blue White Color Smooth	Speed/Brightness Adjustable
7	Red Blue Color Smooth	Speed/Brightness Adjustable	16	Yellow Purple Cyan Color Smooth	Speed/Brightness Adjustable
8	Green Blue Color Smooth	Speed/Brightness Adjustable	17	RGB Color Smooth	Speed/Brightness Adjustable
9	Red Yellow Color Smooth	Speed/Brightness Adjustable	18	Full-color Smooth	Speed/Brightness Adjustable

7. System Diagram:

The receivers can be divided into 1~10 zones within effective distance(1pc receiver per zone), no wiring needed between the receivers.



8. Wiring Diagram:

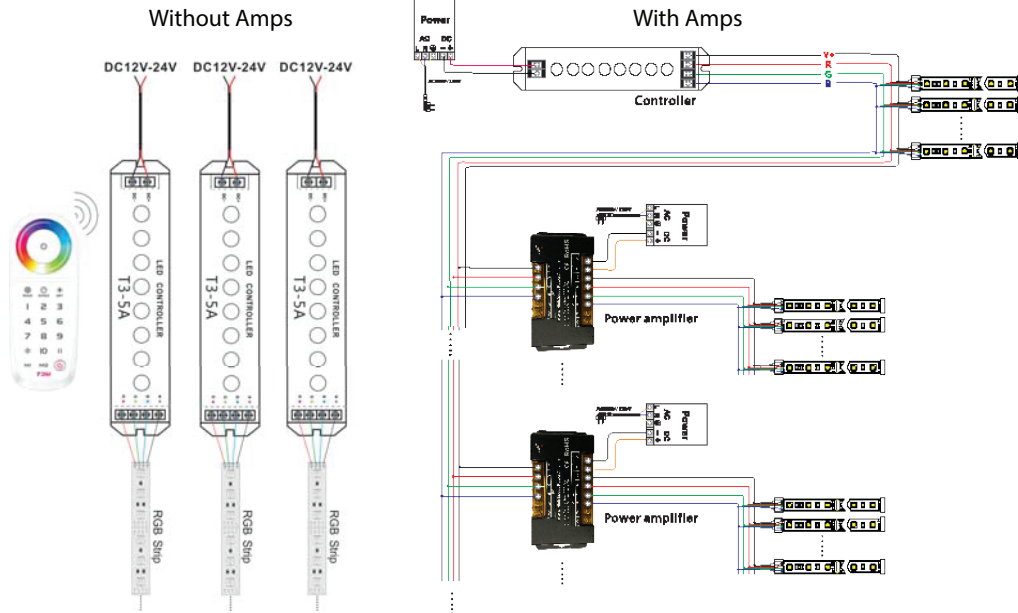

9. The Charging Methods for Remote Control:

1. When charging, please connect USB cable to the mobile charger or computer with the USB interface.
2. The blue indicator light flickers while charging, and turns green means the charging is completed. The remote control can be chargeable even at the OFF state, on which the indicator light is black.
3. No memory effect in the lithium battery of remote control. Follow the standard charging procedure even for the first three times, no need over charge.
4. Red indicator light flickers meaning low battery and need to be charged. charging in low battery will affect life of battery.
5. The remote should be full charged and stored under low cold drying while a long time without being operated. And please full recharge every 3 months.

10. Attention:

1. The product shall be installed and serviced by a qualified person.
2. This product is non-waterproof. Please avoid the sun and rain. When installed outdoors please ensure it is mounted in a water proof enclosure.
3. Good heat dissipation will prolong the working life of the controller. Please ensure good ventilation.
4. Please check if the output voltage of any LED power supplies used comply with the working voltage of the product.
5. Please ensure that adequate sized cable is used from the controller to the LED lights to carry the current. Please also ensure that the cable is secured tightly in the connector.
6. Ensure all wire connections and polarities are correct before applying power to avoid any damages to the LED lights.
7. If a fault occurs please return the product to your supplier. Do not attempt to fix this product by yourself.

11. Installation Instructions for the T3-5A (P-C315) Controller (1 or more)

1. Ensure the primary power going to the power supply is turned off or disconnected.
2. Insert the positive (red) and negative (black) wires from the secondary, low voltage side of the power supply into the positive (DC+) and negative (DC-) terminals on the incoming side of the controller.
3. Insert the positive (gray) wire from the Principal Street Fighter RGB or Principal RGB Light Tape into the positive (+) terminal on the outgoing side of the controller. Repeat this process by inserting the remaining blue, green and red wires into the "B", "G", and "R" terminals respectively.
4. Each additional power supply in the sign will require an additional T3-5A controller; repeat Steps 1-3 for each one.
5. After connecting all wires, turn primary power on and turn on the controller unit.
6. If using only the T3-5A controller, please see Section 5 for instructions on how to pair and program the T3M remote.

12. Installation Instructions for the T3-5A Controller with PL-GL-CT-B (P-A318) amplifiers

1. Ensure the primary power going to the power supply is turned off or disconnected.
2. When using the P-A318 amplifiers, start by repeating Steps 2-3 outlined in Section 11 for the T3-5A controller and the first power supply.
3. Using additional RGB wire (cut to the required length), insert the positive wire into the positive (+) terminal on the outgoing side of the controller. Repeat this process by inserting the remaining blue, green and red wires into the "B", "G", and "R" terminals respectively.
4. On the amplifier, insert the positive (red) and negative (black) wires from the secondary, low voltage side of the power supply into the positive (DC+) and negative (DC-) terminals on the incoming side of the amplifier.
5. Using the extra RGB wire from the controller, insert the positive wire into the positive (V+) terminal on the incoming side of the amplifier. Repeat this process by inserting the remaining blue, green and red wires into the "B", "G", and "R" terminals respectively.
6. Insert the positive (gray) wire from the Principal Street Fighter RGB or Principal RGB Light Tape into the positive (+) terminal on the outgoing side of the controller. Repeat this process by inserting the remaining blue, green and red wires into the "B", "G", and "R" terminals respectively.
7. Repeat Steps 2-6 for each additional amplifier needed.